

Model 220 Electrical: Installation and Operating Instructions

Hazardous Locations Division Classified Electrical Configurations: A, B, J, & K

ELECTRICAL

Upon receipt of your order, please review the ratings plate to verify that the model number and the electrical ratings match the product that you ordered. Figure 1 is the ratings plate for Electrical Configuration J or K (Division 1 approval) and Figure 2 is the Rating Plate for Electrical Configuration A or B (Division 2 approval). **Please read the Cautions listed on the Rating Plate as they are different for each Electrical Configuration.**



FIGURE 1

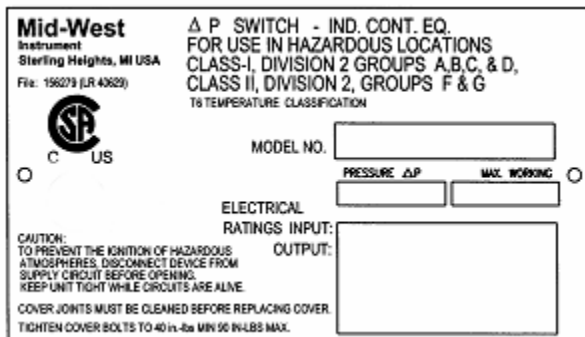

FIGURE 2

WARNING: IN HAZARDOUS LOCATIONS REMOVE POWER FROM THE UNIT BEFORE REMOVING THE COVER.

WARNING: DO NOT TOUCH SURFACE OF THE PRINTED CIRCUIT BOARD IF THE UNIT IS POWERED. HIGH VOLTAGE MAY BE PRESENT.

WARNING: ELECTRICAL CONNECTIONS SHOULD BE PERFORMED BY QUALIFIED PERSONNEL AND MEET THE REPRESENTATIVE COUNTRY'S NATIONAL ELECTRICAL CODE.

WARNING: FAILURE TO CONNECT TO THE PROTECTIVE CONDUCTOR TERMINAL MAY RESULT IN A SHOCK HAZARD.

DIVISION 1 LOCATIONS:



Electrical Configurations J & K are 3rd Party Certified for Class 1, Division 1, Groups B, C & D; Class 2, Division 1, Groups E, F, & G Hazardous Locations. **All Electrical Specification Input & Output Combinations are approved for this classification.** This enclosure does not have a NEMA 4X rating.

This configuration has T6 Temperature classification for all input and output combinations except for the H input option which has a T4A Temperature classification.

For Electrical Specification Input Option A in combination with Output Options A through H, a seal is not required. This configuration can also be classified as a "Simple Apparatus" for use in an Intrinsically Safe System.

For Electrical Specification Input options B through H in combination with Output option R, a seal is required within 18" of the enclosure. Please refer to National Electrical Code requirements.

Caution: Do not scratch, nick, or dent mating surfaces of the gauge body and the cover during maintenance. The integrity of the flame-proof enclosure is dependent upon this metal to metal seal.



If cover bolts are lost contact Mid-West Instrument for Replacement.

Clean Metal joint area with non-abrasive cloth after any maintenance activity that requires the cover to be removed. A small amount of non-hardening grease may be applied in the joint area.

WARNING: To meet Hazardous Location's Requirements, torque the cover bolts to the specified values on the Ratings plate.

DIVISION 2 LOCATIONS:



Electrical Configurations A & B (without Relay Output) are 3rd Party Certified for Class I, Division 2, Groups A, B, C, & D; Class 2, Division 2 Groups F & G Hazardous Locations. **Only Electrical Specification Input Option A in combination with Output Options A through H are approved for this location.** This enclosure does have a NEMA 4X rating.

This configuration has a T6 Temperature classification.

This configuration can also be classified as a "Simple Apparatus" for use in an intrinsically safe System.

Note: The assembly may be ordered with a relay output and NEMA 4X rating; however it will not carry a 3rd party certification for use in Hazardous Locations.

General Information:

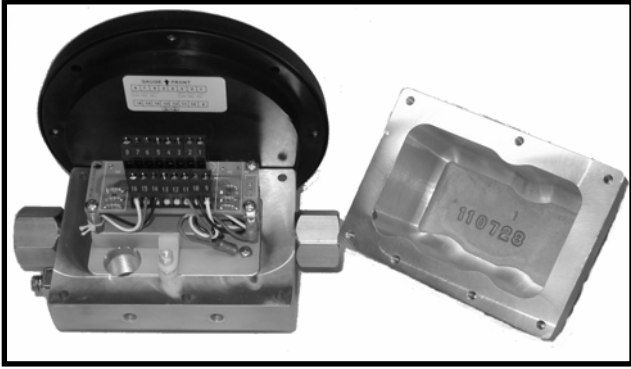

FIGURE 3

Switch Configurations:

The Model 220 indicating / non-indicating differential pressure switch is configured with one of the outputs identified in the table below.

OUTPUT RATINGS (Resistive Load)

Type	SPST	SPDT	SPDT	DPDT Relay
ELEC Spec.	A	A	A	B,C,D,E,F, G, H
Output Option Code	E, F, or G	H	A	R
*Power	60 W	60 W	3W	N/A
Max. Current	3 Amps	1.0 Amps	0.25 Amps	10 Amps
Max. Volts VAC/ VDC	240	240	125	277 / 30
Setting (F.S.)	15% to 90%	25% to 90%	10% to 90%	15% to 90%
Hysteresis (Max/Nom)	20% / 9% Full Scale(F.S.)	20% / 18% Full Scale(F.S.)	10% / 6% Full Scale(F.S.)	20% / 10% Full Scale(F.S.)
Repeatability	1% F.S.	1% F.S.	1% F.S.	1% F.S.

Table I

* Product of the switching voltage and current shall not exceed the power rating of the device.

Hermetically Sealed Switch Outputs:

Electrical Specification Input Option "A" identifies that your unit does not need input power to operate the switch output and that your unit is equipped with Hermetically Sealed Reed switches. The "A" option matched with Output Options A, E, F, G, & H identifies the output capability of your unit. Depending on the electrical configuration specified on the order (A, B, J, or K), your unit will be equipped with 1 or 2 independently adjustable reed switches.

Interface to the 16 position terminal strip shown in Figure 1 is defined in Table II.

Electrical Options	Qty Sw.	Function	Terminal Connections	
			Switch Adjust Low Port	Switch Adjust Hi Port
AAA, JAA, AAH, JAH	1	SPDT	1(COM), 2(NO), 3 (NC)	No Connection
BAA, KAA, BAH, KAH	2	SPDT	1(COM), 2(NO) 3 (NC)	8(COM), 7(NO) 6 (NC)
AAE, JAE	1	SPST NO	1,2	No Connection
AAF, JAF	1	SPST NC	1,3	No Connection
BAE, KAE	2	SPST NO	1,2	8,7
BAF, KAF	2	SPST NC	1,3	8,6
BAG, KAG	2	SPST 1 NO, 1NC	1, 3 NC	8, 7 NO

Table II

Chassis connection is to position 13

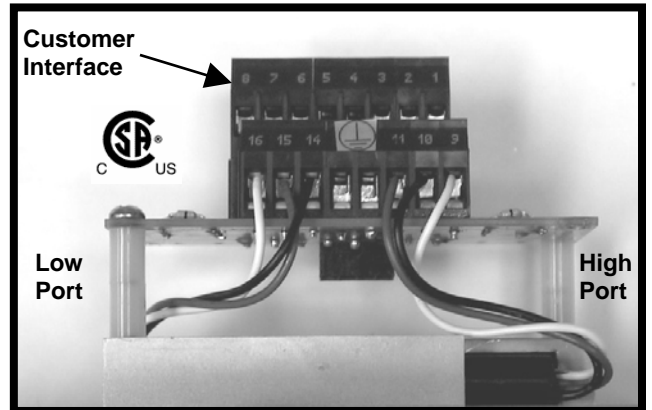

Figure 4: Reed Switch Terminal Strip Output Interface

Customer Interface for the Reed Switch Output Option will be via connections 1 through 8 and connections 12. Do not loosen the connections at positions 9, 10, 11, 13 14, 15 , or 16.

All switch types are field adjustable. The defined range of the adjustment is specified in Table I above. All switches come with a decal to identify adjustment direction to increase the set point. **Do not use excessive force when rotating the adjustment screw as the adjustment mechanism may be damaged (See Figure 5).**

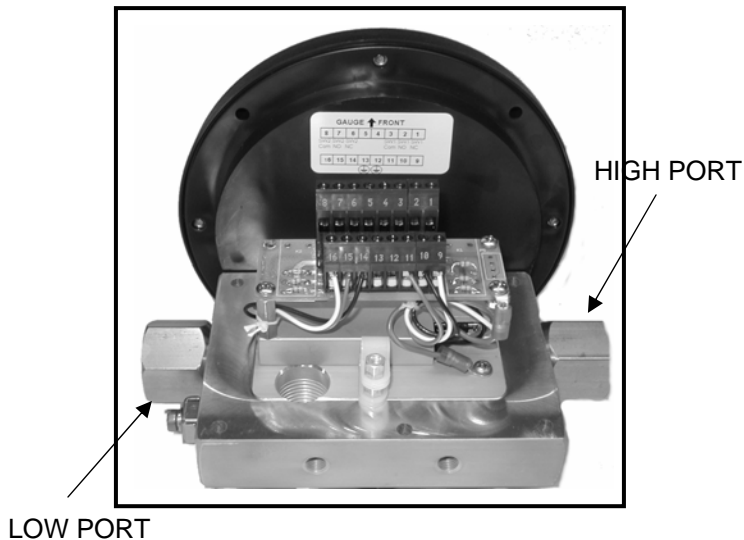

FIGURE 5

Note: Switches can be set below the defined minimum set point however, the switch may not remain activated at maximum PSID. If the unit is set below the defined minimum set point, the customer should verify that the switch remains activated from the set point to full over range of the gauge.

Provide standard protection techniques for the switch contacts for capacitive and inductive loads. Use current limiting techniques near the switch to protect the contacts due to high inrush (i.e.; in line resistor or inductor) for long cable interfaces. Provide clamping devices at or near inductive loads (i.e.; relay). **Maximum wire length between the 3W switch and its load, should not exceed 70 – 100 Feet. for 120 VAC applications.** Contact the factory for assistance regarding this condition.

Relay Output Interface

Electrical Specification Input Option “B” through “H” identifies that your unit will need input power to operate the relay output (output option R). Depending on the electrical configuration specified on the order (A, B, J, or K) your unit will be equipped with 1 DPDT relay output or 2 independently adjustable SPDT relay outputs. Table I identifies the load ratings and the adjustability range of the output.

Interface to the 16 position terminal strip shown in Figure 6 is defined in Table III.

The relay outputs are uncommitted and may be connected to any load provided the load is within the output ratings of the relay. The terminal strip is compatible with 22 – 12 Awg. wire.

Deviations from the above configurations may exist. Therefore check the description block of your order to verify your configuration.

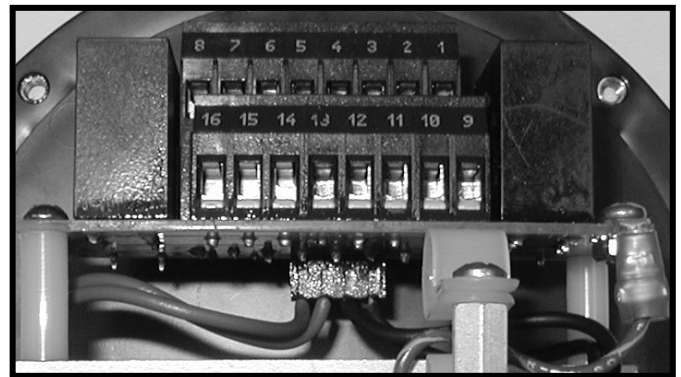

FIGURE 6

Electrical Options	Qty Sw.	Func.	Terminal Connections					
			Switch Adjust Low Port			Switch Adjust Hi Port		
			Com	NO	NC	Com	NO	NC
A*R, J*R	1	DPDT	1 9	2 10	3 11	X	X	X
B*R **, K*R	2	SPDT	1	2	3	8	7	6

TABLE III

- * = Input Power Options B, C, D, E, F, G, & H
- ** = NOT CSA / UL Listed configuration

**Input Power = Position 4 + for DC; Hot for AC
Position 5 Rtn. for DC, Neutral for AC**

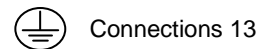

See Decal on Inside Cover for additional connection information.

Switch Output:

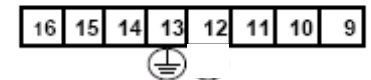
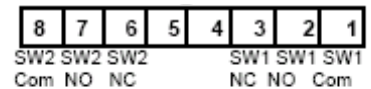

Relay Output: (AC Input)

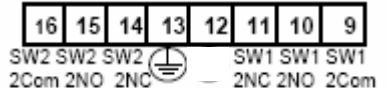
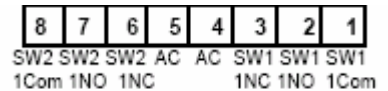

Relay Output: (DC Input)

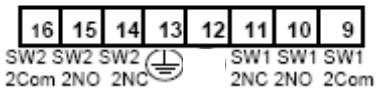
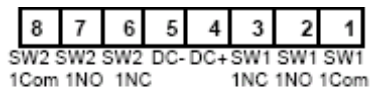

INSTALLATION

Tools Required: 8mm deep metric socket.
Torque wrench
Adjustable or 1.125" wrench (process connections)

CAUTION: DO NOT EXCEED THE MAXIMUM RATED WORKING PRESSURE STATED ON THE RATINGS PLATE.

CAUTION: ALWAYS USE A WRENCH (1.125") ON THE SWITCH'S PROCESS CONNECTIONS TO KEEP THEM IN PLACE WHILE TIGHTENING AND LOOSENING CUSTOMER SUPPLIED PROCESS FITTINGS.

Model 220 Series "Filter Minder" is calibrated and tested prior to shipment and is ready for immediate installation. Use of the following installation procedures should eliminate potential damage and provide optimum trouble-free operation.

CONNECTIONS

1/4" FNPT are provided as standard however check your paperwork for connections ordered. There are two connections on the housing identified as "High" and "Low" for high pressure and low pressure (Fig. 5). Be sure these get plumbed to the proper connections on your system. Improper connection will not damage the instrument, but it will not function properly. Flexible tubing is recommended to minimize the effect of any vibration that may exist.

On liquid service the instrument should be mounted **below** the process connections to facilitate self bleeding. On gas service it should be located **above** the process connections to promote self-draining. If the process contains particulates, a "pigtail" loop or drop leg (manometer "U-tube" configuration) in the tubing will minimize the possibility of it migrating into the instrument.

An optional pipe mounting kit is available for mounting the gauge to a 2" vertical or horizontal pipe (Fig. 3).

WARNING: IN HAZARDOUS LOCATIONS REMOVE POWER FROM THE UNIT BEFORE REMOVING THE COVER.

WARNING: DO NOT TOUCH SURFACE OF THE PRINTED CIRCUIT BOARD IF THE UNIT IS POWERED. HIGH VOLTAGE MAY BE PRESENT.

Remove the cover by using an 8mm hex driver to loosen the bolts from the underside of the gauge body. (see previous cautions and warnings). The bolts are captive in the body of the gauge. A deep metric socket is recommended in order to clear an interference near the bezel of the gauge. (0.48 diameter min 1" long).

Connections to the terminal strip are identified in the following sections. The terminal strip is compatible for wire ranges from 12-22 AWG (3.3 - .32 mm²). Optionally, each connection can be field wired with multiple wires connected to one contact. You may connect two (2) 22 – 16 AWG (0.33 -1.3 mm²) wires into one connection. Recommended screw torque is 6 in. lbs. (0.113 newton-meter) to tighten the terminal strip screw.

Each Assembly is provided with strain relief clamps. Use these clamps to provide strain relief when field wiring the instrument.

For the non-gasketed assembly, clean both mating metal surfaces prior to re-assembly (see previous cautions and warnings). A small application of a suitable, non-hardening grease may be applied to the mating metal surfaces. Replace cover making sure there are no wires pinched between the cover and the gauge body. Re-tighten the screws within the range of 60 to 75 in-lbs.

TROUBLE SHOOTING

1. Gauge does not indicate differential.

- A. Check for proper hook up, high to "hi" and low to "lo".
- B. Make certain block valves are open and, if using a 3-valve manifold, that the equalizer (balance) valve is closed.
- C. If A & B check out correctly, loosen or disconnect the high pressure line to determine if there is pressure to the instrument.
- D. If there is pressure to the instrument, check to determine that there is differential across the unit being monitored. If so, contact the factory for assistance and/or an "RGA" (return goods authorization) number to return the instrument for repair or replacement.

2. Switch doesn't function

- A. Make sure you have supplied power (proper voltage) to the unit if you ordered the power relay unit. The reed switch output units do not require power.
- B. Check that you are wiring to the correct Interface terminals.
- C. Check the reed switch interfaces to the terminal board for loose connections. For the power relay the reed switch(es) connect to the terminal strip on the underside of the PCB. For the reed switch outputs the reed switch(es) connect to positions on the bottom row of the terminal strip on the top of the PCB (see Figure 4).
- D. Make sure that the switch load does not exceed the specified wattage rating of the switch. (steady-state and transient). For this condition you must contact the factory

3. Gauge accuracy and set point problems:

- A. Verify gauge is not in an electromagnetic / magnetic environment. i.e.; close proximity to high current power lines.
- B. All others, contact the factory for assistance.

STANDARD MODEL SPECIFICATIONS

220-AC-02-0(JAA), 4000 P.S.I.G. Working Pressure, Aluminum wetted pressure containing body assembly, stainless steel/ceramic magnet internals, Buna N Seals, 4 1/2" Round Dial, 1/4" FNPT End Connections, Engineering Plastic Gauge Case with Shatter Resistant Acrylic Lens. One 3W, 0.25 AMP, 125 VAC/VDC SPDT Reed Switch with terminal strip in an Aluminum Explosion-proof switch enclosure with 1/2" FNPT Electrical Access **3rd Party Certified**

220-SC-02-0(JAA), 4000 P.S.I.G. Working Pressure, 316 S.S. wetted pressure containing body assembly, , stainless steel/ceramic magnet internals, Buna N Seals, 4 1/2" Round Dial, 1/4" FNPT End Connections, Engineering Plastic Gauge Case with Shatter Resistant Acrylic Lens. One 3W, 0.25 AMP, 125 VAC/VDC SPDT Reed Switch with terminal strip in an Aluminum Explosion-proof switch enclosure with 1/2" FNPT Electrical Access. **3rd Party Certified**

PART NUMBERING SYSTEM

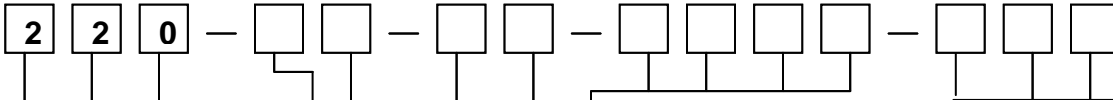

① BASIC MODEL NUMBER

② MATERIAL

- A. Aluminum Body, Aluminum Bore , S.S. Piston
- S. Aluminum Body, 316 S.S. Bore, S.S. Piston
- Z. Special

③ DIAL SIZE (Engineering Plastic Housing Unless Stated)

- C. 4-1/2" Round Dial Uni-Directional Dial
- F. 4-1/2" Round Aluminum Dial Housing
- T. Differential Pressure Switch Only (**Without Indication**)
- Z. Special (Uncoded Options)

④ SEALS

- 0. Buna N (**Standard**)
- 1. *Viton®
- 2. Neoprene
- 5. Ethylene Propylene
- 6. Perfluoroelastomer
- 9. Special (Uncoded Options)

⑤ CONNECTIONS

- 2. 1/4" FNPT End Connections (**Standard**)
- 7. 1/2" FNPT End Connections
- 9. Special (Uncoded Options)

⑥ OPTIONS (Up to four options)

- 0. None
- F. Pipe Mounting Kit (Carbon Steel)
- G. Pipe Mounting Kit (Stainless Steel)
- M. Maximum Indicator Follower Pointer
- Q. CRN (Canadian Registration Number)
- S. Shatterproof Lens (4 1/2" Metal Front Only)
- T. Oxygen Cleaning
- U. S.S. Tag with S.S. Wire
- V. S.S. Tag with S.S. Screw
- Y. S.S. End Fittings with Al Body (Material Option A)
- Z. Special (Uncoded Options)

NOTE: Not all options available in combination with Other options.

* Viton® is a Registered Trademark of DuPont Dow Elastomers

** Teflon® is a Registered Trademark of DuPont

⑦ ELECTRICAL CONFIGURATIONS (Select One)

(Switch Adjustable Range 10-90% except where stated below) (T6 Temperature Class unless specified otherwise)

- A. One Control Switch in NEMA4X Enclosure^{1,6,8}
- B. Two (2) Control Switches in NEMA4X Enclosure^{1,6,7,8}
- J. One (1) Control Switch in NEMA7 (Exp. Proof Enclosure)²
- K. Two (2) Control Switches in NEMA7 (Exp. Proof Enclosure)²
- R.
- S.
- Z. Special

⑧ ELECTRICAL SPECIFICATIONS (Select 1 Input and 1 Output)

INPUT OPTIONS:

- A. No Input Power (**For Reed Outputs A, E, F, G, H**)
- B. 5/6 VDC
- C. 12 VDC
- D. 24 VDC
- E. 48 VDC
- F. 24 VAC
- G. 120 VAC
- H. 240 VAC T4A Temp Class

R RELAY OUTPUT OPTION

⑨ OUTPUT OPTIONS: (Resistive Load)³

- A. S.P.D.T., Reed, 3 W, 0.25 Amp, 125 VAC/VDC
- E. S.P.S.T., Reed, 60 W, 3 Amp, 240 VAC/VDC (N.O.)⁽⁴⁾
- F. S.P.S.T., Reed, 60 W, 3 Amp, 240 VAC/VDC (N.C.)⁽⁴⁾
- G. Two (2) S.P.S.T., Reeds, 60 W, 3 Amp, 240 VAC/VDC (One Normally Open, One Normally Closed B, K & S Electrical Configurations Only)⁽⁴⁾
- H. S.P.D.T., Reed, 60 W, 1 Amp, 240 VAC / VDC⁽⁵⁾
- R. D.P.D.T. Relay, 10 A, @ 30 VDC, 120 / 240 VAC⁽⁴⁾⁽⁸⁾
- Z. Special (**Contact Factory**)

- (1) Complete Assembly 3rd Party Certified, Rated Class I, Div II, Groups A,B,C, & D; Class II Division II, Groups F & G. (R Output option excluded)
- (2) Complete Assembly 3rd Party Certified, Rated Class I, Div I, Groups B C, & D; Class II Division I, Groups E, F, & G.
- (3) For output options A through H, the product of the switching voltage and current shall not exceed the power rating.
- (4) Switch adjustable range 15 – 90 % of the gauge full scale range.
- (5) Switch adjustable range 25 – 90 % of the gauge full scale range.
- (6) Enclosure Type 4/4X
- (7) For Electrical configurations B, K, & S SPDT relay output only.
- (8) Electrical configuration A & B in combination with Output Option R is not rated for hazardous locations.

MOUNTING INFORMATION & DIMENSIONAL DATA

MODEL 220 4 1/2" PLASTIC DIAL ASSY.

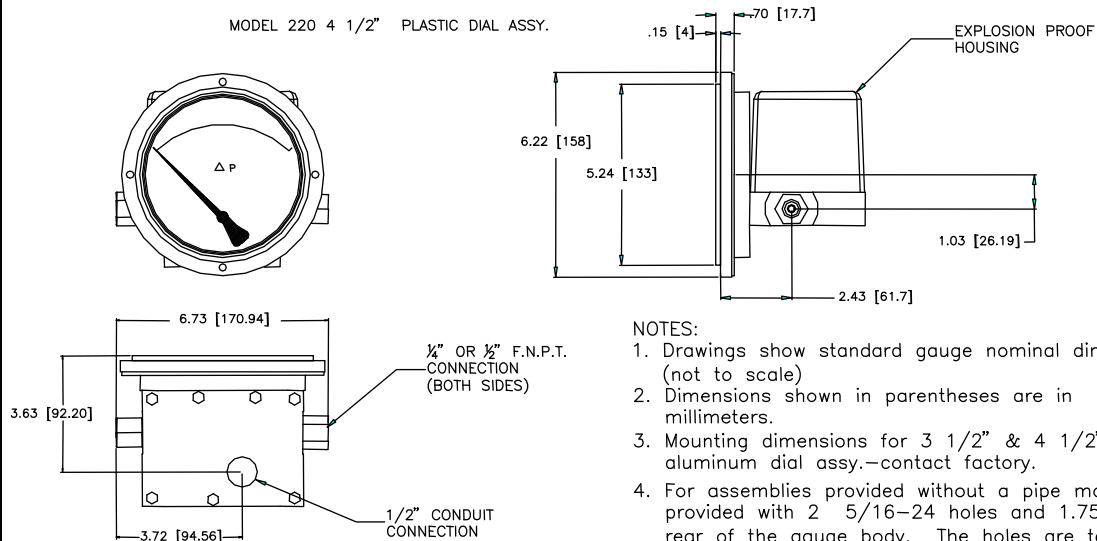

NOTES:

1. Drawings show standard gauge nominal dimensions. (not to scale)
2. Dimensions shown in parentheses are in millimeters.
3. Mounting dimensions for 3 1/2" & 4 1/2" aluminum dial assy.—contact factory.
4. For assemblies provided without a pipe mounting bracket, the switch is provided with 2 5/16–24 holes and 1.75" separation located on the rear of the gauge body. The holes are tapped a minimum of 6.2 threads deep. Customer selected bolts must allow for 1 free thread after engagement with the gauge body.

PROOF PRESSURE: 16,000 PSI

WORKING PRESSURE: 4000 PSI

TEMPERATURE LIMITS: -40° F (-40° C) TO + 185° F (+85° C)** - These limits are based on the entire instrument being saturated to these temperatures. System (process) temperatures may exceed these limitations with proper installation. Contact our customer service representative for details.

**** -40° F (-40° C) TO + 160° F (+70° C) For Output Option R (Relay Output)**

STANDARDS: The Model 220 Series differential pressure gauges either conform to and/or are designed to the requirements of the following standards:

ASME B1.20.1
ASME B40.1
CSA-C22.2 No. 14, 25, and 30

UL Std. No. 50, 508, 698, and 1203
NEMA Std. No. 250
SAE J514

Warning: The suitability of the application and installation of this differential pressure switch is the responsibility of the end user. The applicable certifications, listings apply to the differential pressure switch only.

**Mid-West[®]
Instrument**

6500 Dobry Dr. Sterling Heights, MI 48314

(586)254-6500 FAX (586)254-6509

E-Mail: sales@midwestinstrument.com

Web Page: www.midwestinstrument.com